



PCA T8 EXCEL one4all Ip x!tec, 3x18 W and 4x18 W EXCEL T8

Product description

- Processor-controlled ballast with x!tec inside
- Highest possible energy class CELMA EEI = A1 BAT[Ⓞ]
- Noise-free precise control via DALI or DSI signal, switchDIM or corridorFUNCTION
- OEM-specific reserved memory areas
- Extended DALI commands
- 5-year guarantee

Interfaces

- DALI
- DSI
- switchDIM (with memory function + selectable dimming rate)
- corridorFUNCTION (individually programmable)

Functions

- Intelligent Temperature Guard (overtemperature protection)
- Intelligent Voltage Guard (overvoltage indication and undervoltage shutdown)
- Optimum filament heating in any dimmer setting
- Disconnection of filament heating from a dimming level of approx. 90 % for maximum energy efficiency (SMART-Heating concept)
- Fade rates between 50 ms and 90 s (min. – max.)
- Automatically triggered emergency lighting value in DC mode, can be set between 1 and 100 %
- For emergency lighting systems as per EN 50172
- Automatic start after replacement of defective lamps
- Automatic shutdown if the lamp is faulty
- Dimming possible in DC mode

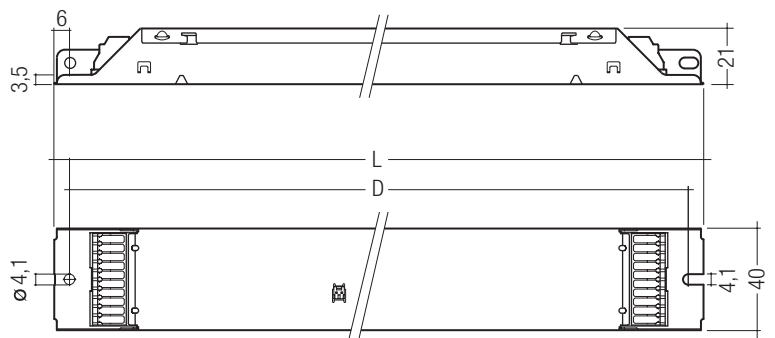

Technical data

Mains voltage range	220 – 240 V
AC voltage range	198 – 264 V
DC voltage range	176 – 280 V (lamp start \geq 198 V DC)
Mains frequency	0 / 50 / 60 Hz
Overvoltage protection	320 V AC, 1 h
Typ. power input on standby	< 0.5 W
Protective hot restart	0.5 s for AC / 0.2 s for DC
Dimming range, 3 lamps	5 – 100 %
Dimming range, 4 lamps	1 – 100 %
Lamp start possible from	5 % (3 lamps), 1 % (4 lamps)
Operating frequency	~ 40 – 100 kHz
Type of protection	IP20

Ordering data

Type	Article number	Packaging, carton	Packaging, pallet	Weight per pc.
For luminaires with 3 lamps				
PCA 3x18 T8 EXCEL one4all Ip x!tec	22185247	20 pc(s).	600 pc(s).	0.303 kg
For luminaires with 4 lamps				
PCA 4x18 T8 EXCEL one4all Ip x!tec	22185250	20 pc(s).	600 pc(s).	0.338 kg



Standards, page 2

Wiring diagrams and installation examples, page 5

Specific technical data

Lamp wattage	Lamp type	Type	Article number	Dimensions L x W x H	Hole spacing D	Lamp power [Ⓜ]	Circuit power [Ⓜ]	EEI	Current at 50 Hz 230 V [Ⓜ]	λ at 50 Hz 230 V	tc point max.	Ambient temperature ta [Ⓜ]
For luminaires with 3 lamps												
3 x 18 W	T8	PCA 3x18 T8 EXCEL one4all Ip x!tec	22185247	360 x 40 x 21 mm	350 mm	48.5 W	51 W	A1 BAT	0.23 A	0.97	75 °C	-25 ... 60 °C
For luminaires with 4 lamps												
4 x 18 W	T8	PCA 4x18 T8 EXCEL one4all Ip x!tec	22185250	360 x 40 x 21 mm	350 mm	65.0 W	69 W	A1 BAT	0.31 A	0.98	80 °C	-25 ... 60 °C

[Ⓞ] According to the EU directives on ecodesign requirements (EC) No. 245/2009 and (EC) No. 347/2010.

[Ⓜ] Valid at 100 % dimming level.

[Ⓜ] +10 °C to ta max: unrestricted dimming. -25 °C to +10 °C: unrestricted dimming from 100 % to 30 %.

-25 °C to +10 °C, dimming below 30 %: malfunction possible but no damage to ECG. This applies to AC and DC operation.

Standards

EN 55015
EN 60929
EN 61000-3-2
EN 61347-2-3
EN 61547
Suitable for emergency installations according to EN 50172

Lamp starting characteristics

Warm start
Starting time 0.5 s with AC
Starting time 0.2 s with DC
Start at any dimming level

AC operation

Mains voltage
220–240 V 50/60 Hz
198–264 V 50/60 Hz including safety tolerance ($\pm 10\%$)
202–254 V 50/60 Hz including performance tolerance ($+6\% / -8\%$)

DC operation

220–240 V 0 Hz
198–280 V 0 Hz certain lamp start
176–280 V 0 Hz operating range
Use in emergency lighting installations according to EN 50172 or for emergency luminaires according to EN 61347-2-3 appendix J.

Emergency units

The "PCA T8 EXCEL Ip xitec" ballasts are compatible with all emergency units from Tridonic. See the table in the data sheet. Also all "5-pole" emergency units can be used. When used with other emergency units tests are necessary.

Temperature range

Unlimited dimming range from 10 °C to t_a max.
-25 °C to +10 °C: dimming operation from 100 % to 30 %. If dimm level goes below 30 % malfunction possible, but no electronic ballast damage.
This applies to AC and DC operation.

Mains currents in DC operation (at 70 % light output)

Type	Wattage	Mains current at $U_n = 220 V_{DC}$	Mains current at $U_n = 275 V_{DC}$
PCA 3x18 T8 EXCEL one4all Ip xitec	3x18 W	0.22 A	0.17 A
PCA 4x18 T8 EXCEL one4all Ip xitec	4x18 W	0.28 A	0.22 A

Ballast lumen factor AC operation (AC-BLF) EN 60929 8.1

Type	Wattage	AC-BLF at $U = 230 V_{AC}$
PCA 3x18 T8 EXCEL one4all Ip xitec	3x18 W	0.98
PCA 4x18 T8 EXCEL one4all Ip xitec	4x18 W	0.99

The ballast lumen factor for AC operation (AC-BLF) does not alter from $U_n = 198 V_{AC}$ to $U_n = 254 V_{AC}$.
The ballast lumen factor for DC operation (DC-BLF) on the basis of an automatic power reduction of the ballasts (default value is 70 %) will be smaller than AC. It does not alter in the DC operating range (198–280 V DC).

Harmonic distortion in the mains supply (at 230 V / 50 Hz)

Type	Wattage	THD	3	5	7	9	11
PCA 3x18 T8 EXCEL one4all Ip xitec	3x18 W	7	4	2	2	1	1
PCA 4x18 T8 EXCEL one4all Ip xitec	4x18 W	7	4	2	1	1	1

Dimming

Dimming curve is adapted to the eye sensitiveness.

Dimming range:

4-lamp: 1 % to 100 %, 3-lamp: 5 % to 100 %

Digital control with:

- DSI signal: 8 bit Manchester Code
Speed 1 % to 100 % in 1.4 s
- DALI signal: 16 bit Manchester Code
Maximum speed 1 % to 100 % in 550 ms (adjustable between 50 ms and 90 s)
Programmable parameter:
Minimum dimming level
Maximum dimming level
Defaults 3-lamp minimum = 5 %
maximum = 100 %
Defaults 4-lamp minimum = 1 %
maximum = 100 %

Control input (DA/D1, DA/D2)

Digital DALI signal or a push-to-make switch (switchDIM) can be wired on the same terminals (DA and DA).

Digital signal DALI/DSI

The control input is non-polar and protected against accidental connection with a mains voltage up to 264 V. The control signal is not SELV. Control cable has to be installed in accordance to the requirements of low voltage installations.

Different functions depending on each module.

SMART interface

An additional interface for the direct connection of the SMART-LS II Ip¹⁾ light sensor. The sensor registers actual ambient light and maintains the individually defined lux level.

After every mains reset the SMART interface automatically checks for an installed sensor. With the sensor installed the PCA T8 EXCEL one4all Ip xtec automatically runs in the constant lux level mode. ON/OFF switch via mains, switchDIM or DALI/DSI signal.

DALI/DSI signal = 0 switches off,

DALI/DSI signal ≥ 1 switches on.

With relative DALI dimming commands (e.g. up, down etc.) or switchDIM signals it is possible to change the controlled light level temporarily.

Temporarily means that after a switching cycle OFF/ON command the ballast will start at the preset value determined by the SMART-LS II Ip. The installation of the two wire bus is according to the appropriate low voltage regulations.

switchDIM

Integrated switchDIM function allows a direct connection of a push to make switch for dimming and switching.

¹⁾ SMART-LS II Ip: article number 86458258

Dimming characteristics

PCA T8 EXCEL one4all Ip xtec

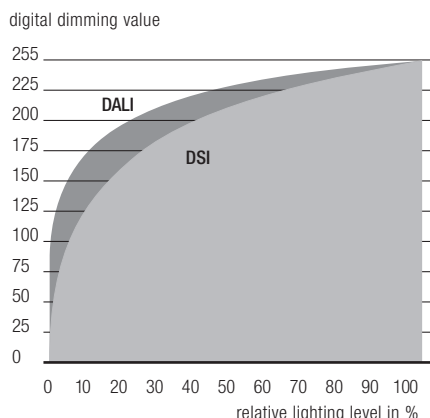

Dimming characteristics as seen by the human eye

Brief push (< 0.6 s) switches ballast ON and OFF. The ballasts switch-ON at light level set at switch-OFF. When the push to make switch is held, PCA ballasts are dimmed. After repush the PCA is dimmed in the opposite direction.

The switchDIM fade time is set to 3 s from min. to max. in the factory settings. With a 20 s push to the push to make switch this fade time can be changed to 6 s. In this instance the switchDIM application will be synchronized to 50 % light level after 10 s and after 20 s the light level rises to 100 % with the new fade time.

At every synchronization (10 s keystroke) the device will reset to 3 s (factory setting)

In installations with PCAs with different dimming levels or opposite dimming directions (e.g. after a system extension), all PCAs can be synchronized to 50 % dimming level by a 10 s push.

Use of push to make switch with indicator lamp is not permitted.

Deactivation: If the corridorFUNCTION is wrongly activated in a switchDIM system (for example a switch is used instead of pushbutton), there is the option of installing a pushbutton and deactivating the corridorFUNCTION mode by five short pushes of the button within three seconds.

switchDIM and corridorFUNCTION are very simple tools for controlling ballasts with conventional momentary-action switches or motion sensors.

To ensure correct operation a sinusoidal mains voltage with a frequency of 50 Hz or 60 Hz is required at the control input.

Special attention must be paid to achieving clear zero crossings.

Serious mains faults may impair the operation of switchDIM and corridorFUNCTION.

Energy saving

PCA T8 EXCEL one4all Ip xtec

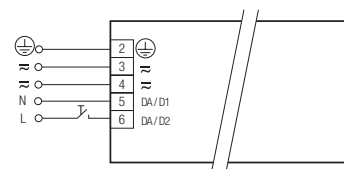
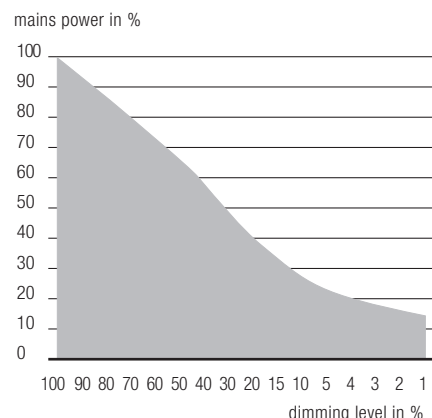

switchDIM PCA T8 EXCEL one4all Ip xtec

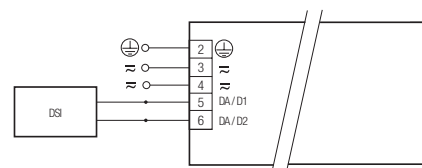

DSI PCA T8 EXCEL one4all Ip xtec

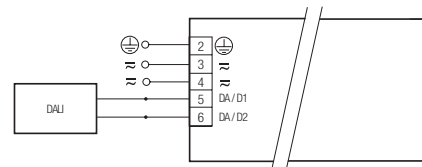

DALI PCA T8 EXCEL one4all Ip xtec

Dimmable ballasts from Tridonic have to be earthed.

Loading of automatic circuit breakers

Automatic circuit breaker type	C10	C13	C16	C20	B10	B13	B16	B20
Installation Ø	1.5 mm ²	1.5 mm ²	1.5 mm ²	2.5 mm ²	1.5 mm ²	1.5 mm ²	1.5 mm ²	2.5 mm ²
PCA 3x18 T8 EXCEL one4all Ip xtec	22	30	42	48	11	15	21	24
PCA 4x18 T8 EXCEL one4all Ip xtec	14	20	28	32	7	10	14	16

Continuous operation: to calculate the protective safety switch see main current, page 1

corridorFUNCTION

Activation: To activate the corridorFUNCTION a voltage of 230V simply has to be applied for five minutes at D1, D2. The unit will then switch automatically to the corridorFUNCTION.

Deactivation: If the corridorFUNCTION is wrongly activated in a switchDIM system (for example a switch is used instead of pushbutton), there is the option of installing a pushbutton and deactivating the corridorFUNCTION mode by five short pushes of the button within three seconds.

Installation instructions

Wiring type and cross section

The wiring can be solid cable with a cross section of 0.5 to 0.75 mm² for push terminal and 0.5 mm² for IDC terminal. For the push-wire connection you have to strip the insulation (8–9 mm).

wire preparation:
0.5 – 0.75 mm²

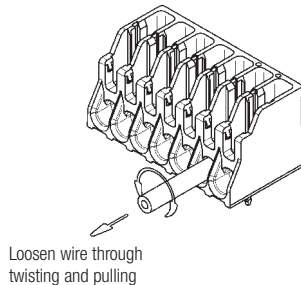
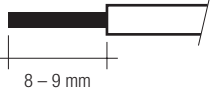

Intelligent Temperature Guard

The intelligent temperature guard protects the PCA T8 EXCEL Ip xitec from thermal overheating by reducing the output power or switching off in case of operation above the thermal limits of the luminaire or ballast. Depending on the luminaire design, the ITG operates at about 5 to 10 °C above T_c temperature.

Intelligent Voltage Guard

Intelligent Voltage Guard is the name of the new electronic monitor from Tridonic. This innovative feature of the PCA family of control gear from Tridonic immediately shows if the mains voltage rises above or falls below certain thresholds. Measures can then be taken quickly to prevent damage to the control gear.

- If the mains voltage rises above approx. 305 V (voltage depends on the ballast type), the lamp starts flashing on and off.
- This signal "demands" disconnection of the power supply to the lighting system.
- The active-current-control of these control gears is protected against failure caused by the high mains currents generated as a result of mains undervoltage. The switch off level depends on lamp wattage and is typically < 140 V.

Operating voltage

Type	Wattage	U _{out}
PCA 3x18 T8 EXCEL one4all Ip xitec	3x14 W	430 V
PCA 4x18 T8 EXCEL one4all Ip xitec	4x14 W	430 V

Wiring advice

The lead length is dependent on the capacitance of the cable.

Ballast Type	Terminal			Maximum capacitance allowed			
	Cold	Middle	Hot	Cold	Middle	Hot	
PCA 3x18 T8 EXCEL one4all Ip xitec	7, 8	9, 10, 14, 15, 16, 17	12, 13	100 pF	50 pF	100 pF	
PCA 4x18 T8 EXCEL one4all Ip xitec	14, 15, 16, 17	7, 8, 9, 10	12, 13, 18, 19	200 pF	50 pF	100 pF	

With standard solid wire 0.5/0.75 mm² the capacitance of the lead is 30–80 pF/m.

This value is influenced by the way the wiring is made.

Lamp connection should be made with symmetrical wiring.

3-lamp devices: Hot and cold leads should be separated as much as possible.

4-lamp devices: Middle and hot leads should be separated as much as possible.

Hot leads (9, 10, 15, 16) and cold leads (11, 12, 13, 14) should be separated as much as possible.

When using two or more dimmable ballasts in one luminaire with separate dimming controls, the lamp leads must be kept separate.

Distance to plate: 5–10 mm

(ideal distance for optimal symmetrical light)

To avoid the damage of the control gear, the wiring must be protected against short circuits to earth (sharp edged metal parts, metal cable clips, louver, etc.).

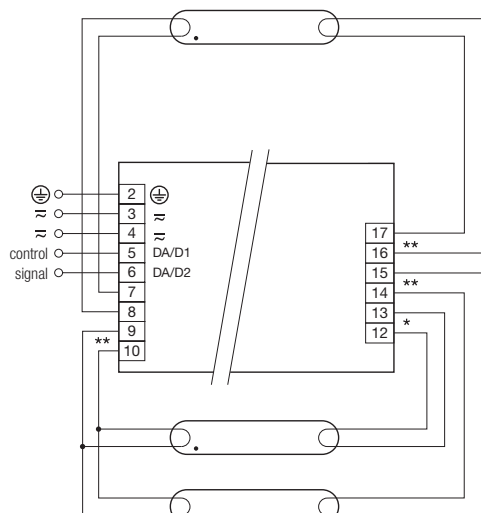

* leads 12, 13: keep wires short, max. 1.0 m
** leads 9, 10, 14, 15, 16, 17: keep wires short, max. 0.5 m
leads 7, 8: max. 2.0 m

PCA T8 EXCEL one4all Ip xitec 3x18W

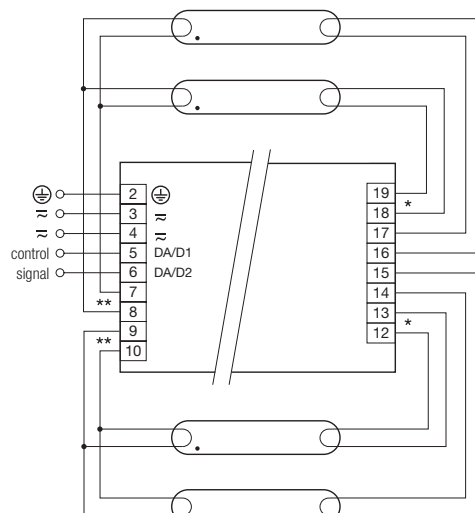

* leads 12, 13, 18, 19: keep wires short, max. 1.0 m
** leads 7, 8, 9, 10: keep wires short, max. 0.5 m
leads 14, 15, 16, 17: max. 2.0 m

PCA T8 EXCEL one4all Ip xitec 4x18W

Dimmable ballasts from Tridonic have to be earthed.

RFI

- Connection to the lamps of the hot leads must be kept as short as possible
- Mains leads should be kept apart from lamp leads (ideally 5–10 cm distance)
- Do not run mains leads adjacent to the electronic ballast
- Twist the lamp leads
- Keep the distance of lamp leads from the metal work as large as possible
- Mains wiring to be twisted when through wiring
- Keep the mains leads inside the luminaire as short as possible

General advise

Electronic ballasts are virtually noise free. Magnetic fields generated during the ignition cycle can cause some background noise but only for a few milliseconds.

Operation on DC voltage

Our ballasts are construed to operate DC voltage and pulsed DC voltage. To operate ballasts with pulsed DC voltage the polarity is absolute mandatory.

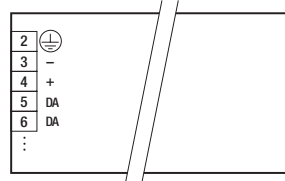

Programming

With appropriate software and a USB interface different functions can be activated and various parameters can be configured in the new PCA T8 EXCEL one4all Ip xitec. All that is needed is a DALI-USB and the software.

MASTER CONFIGURATOR

Full version for programming all the functions and parameters.

pcaCONFIGURATOR

For programming the corridorFUNCTION, device configuration (fade time, ePowerOnLevel, etc.) DC level, compatibility settings, and startup date and for resetting.

corridorFUNCTION CONFIGURATOR

For activating and deactivating the corridorFUNCTION and for project-specific programming of the PCA T8 EXCEL one4all Ip xitec units.

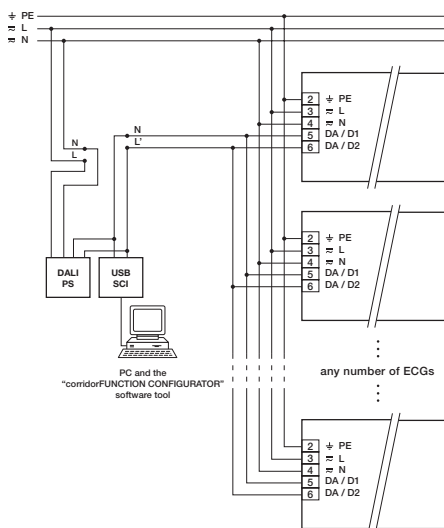

Wiring diagram for programming

Isolation and electric strength testing of luminaires

Electronic devices can be damaged by high voltage. This has to be considered during the routine testing of the luminaires in production.

According to IEC 60598-1 Annex Q (informative only!) or ENEC 303-Annex A, each luminaire should be submitted to an isolation test with 500 V DC for 1 second. This test voltage should be connected between the interconnected phase and neutral terminals and the earth terminal.

The isolation resistance must be at least 2 MΩ.

As an alternative, IEC 60598-1 Annex Q describes a test of the electrical strength with 1500 V AC (or 1.414 x 1500 V DC). To avoid damage to the electronic devices this test must not be conducted.

Additional information

Additional technical information at www.tridonic.com → Technical Data

Guarantee conditions at www.tridonic.com → Services

Life-time declarations are informative and represent no warranty claim.

No warranty if device was opened.