



Driver LC 150W 350–900mA flexC IND sl ADV ADVANCED series

Product description

- Fixed output constant current built-in driver for LED, particularly suitable for industrial applications
- Output current adjustable between 350 – 900 mA
- Max. output power 150 W
- Nominal life-time up to 200,000 h
- 8-year guarantee
- Suitable for mains voltage peaks (burst/surge) up to 4 kV
- Extended temperature range of -40 ... +70 °C

Properties

- White slim metal casing
- Type of protection IP20

Functions

- Adjustable output current (I-select resistor)
- Intelligent Temperature Guard (overtemperature protection)
- Short-circuit proof
- Overload protection
- Suitable for emergency lighting units acc. to EN50172
- Intelligent Voltage Guard (overvoltage and undervoltage shutdown)



Standards, page 4

IP20 

Driver LC 150W 350–900mA flexC IND sl ADV

ADVANCED series

Technical data

Rated supply voltage	220 – 240 V
AC voltage range	198 – 264 V
DC voltage range	176 – 280 V
Mains frequency	0 / 50 / 60 Hz
Overvoltage protection	320 V AC, 48 h
Typ. current (at 230 V, 50 Hz, full load) ^①	700 mA
Typ. current (220 V, 0 Hz, full load, 15 % light level) ^②	150 mA
Leakage current (PE)	< 0,7 mA
Max. input power	160 W
Typ. efficiency (at 230 V, 50 Hz, full load) ^③	95 %
λ (at 230 V, 50 Hz, full load)	0,98
Typ. input current in no-load operation	90 mA
Input power in no-load operation	< 250 mW
In-rush current (peak / duration)	60 A / 200 μ s
THD (at 230 V, 50 Hz, full load)	< 10 %
Time to light (at 230 V, 50 Hz, full load)	< 0,6 s
Time to light (DC mode)	< 0,4 s
Switchover time (AC/DC)	< 0,4 s
Turn off time (at 230 V, 50 Hz, full load)	< 50 ms
Output current tolerance ^④	\pm 3 %
Output LF current ripple (< 300 Hz)	< 2 %
Max. peak output current	\leq output current + 20 %
Max. output voltage	420 V
PWM frequency at DC operation ^⑤	500 Hz
Suitable for burst / surge peaks up to (between L - N)	4 kV
Suitable for burst / surge peaks up to (between L/N - PE)	4 kV
Burst / surge peaks output side against PE	4 kV
Dimensions L x W x H	425 x 30 x 28 mm

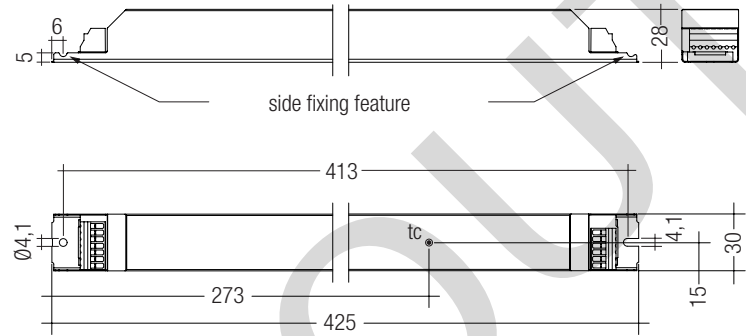

Ordering data

Type	Article number	Packaging carton	Packaging pallet	Weight per pc.
LC 150W 350-900mA flexC IND sl ADV	28000916	10 pc(s).	480 pc(s).	0.374 kg

Specific technical data

Type	Output current ^④	Min. forward voltage	Max. forward voltage ^③	Max. output power ^③	Typ. power consumption (at 230 V, 50 Hz, full load)	Typ. current consumption (at 230 V, 50 Hz, full load)	Max. casing temperature t_c	Ambient temperature t_a max.	I-select resistor value
LC 150W 350-900mA flexC IND sl ADV	350 mA	126 V	300 V	105 W	110 W	478 mA	90 °C	-40 ... +70 °C	open
	375 mA	126 V	300 V	113 W	118 W	513 mA	90 °C	-40 ... +70 °C	71.50 k Ω
	400 mA	126 V	300 V	120 W	125 W	543 mA	90 °C	-40 ... +70 °C	66.50 k Ω
	425 mA	126 V	300 V	128 W	133 W	578 mA	90 °C	-40 ... +70 °C	61.90 k Ω
	450 mA	126 V	300 V	135 W	141 W	613 mA	90 °C	-40 ... +70 °C	57.60 k Ω
	475 mA	126 V	300 V	143 W	149 W	648 mA	90 °C	-40 ... +70 °C	53.60 k Ω
	500 mA	126 V	300 V	150 W	156 W	678 mA	90 °C	-40 ... +70 °C	49.90 k Ω
	525 mA	126 V	286 V	150 W	156 W	678 mA	90 °C	-40 ... +70 °C	45.30 k Ω
	550 mA	123 V	273 V	150 W	156 W	678 mA	90 °C	-40 ... +70 °C	42.20 k Ω
	575 mA	117 V	261 V	150 W	156 W	678 mA	90 °C	-40 ... +70 °C	38.30 k Ω
	600 mA	113 V	250 V	150 W	158 W	687 mA	90 °C	-40 ... +70 °C	35.70 k Ω
	625 mA	108 V	240 V	150 W	158 W	687 mA	90 °C	-40 ... +70 °C	32.40 k Ω
	650 mA	104 V	231 V	150 W	158 W	687 mA	90 °C	-40 ... +70 °C	28.70 k Ω
	675 mA	100 V	222 V	150 W	158 W	687 mA	90 °C	-40 ... +70 °C	26.10 k Ω
	700 mA	96 V	214 V	150 W	158 W	687 mA	90 °C	-40 ... +70 °C	22.00 k Ω
	725 mA	93 V	207 V	150 W	158 W	687 mA	90 °C	-40 ... +70 °C	17.40 k Ω
	750 mA	90 V	200 V	150 W	158 W	687 mA	90 °C	-40 ... +70 °C	15.00 k Ω
	775 mA	87 V	194 V	150 W	158 W	687 mA	90 °C	-40 ... +70 °C	12.40 k Ω
	800 mA	84 V	188 V	150 W	158 W	687 mA	90 °C	-40 ... +70 °C	10.00 k Ω
	825 mA	82 V	182 V	150 W	158 W	687 mA	90 °C	-40 ... +70 °C	7.68 k Ω
850 mA	79 V	177 V	150 W	160 W	696 mA	90 °C	-40 ... +70 °C	5.36 k Ω	
875 mA	77 V	171 V	150 W	160 W	696 mA	90 °C	-40 ... +70 °C	3.16 k Ω	
900 mA	75 V	167 V	150 W	160 W	696 mA	90 °C	-40 ... +70 °C	short circuit (0 Ω)	

^① Depending on the selected output current.

^② $\pm 10\%$.

^③ At full load.

^④ Output current is mean value.

ACCES-
SORIES

I-SELECT PLUG

Product description

- Ready-for-use resistor to set output current value
- Resistor is base isolated
- Resistor power 0.25 W
- Resistor value tolerance $\pm 1\%$

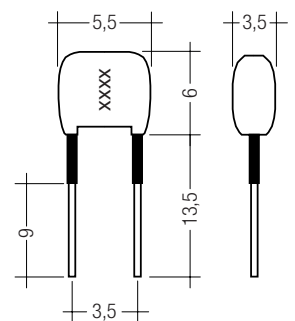
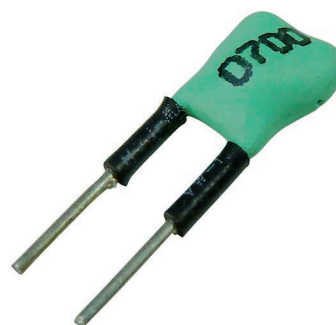

Ordering data

Type	Article number	Colour	Marking	Resistor value	Packaging bag	Weight per pc.
I-SELECT PLUG MAX GR	28000274	Grey	MAX	0 Ω	10 pc(s).	0.001 kg
I-SELECT PLUG 500mA GN	28000277	Green	0500	499 k Ω	10 pc(s).	0.001 kg
I-SELECT PLUG 700mA GN	28000278	Green	0700	22.0 k Ω	10 pc(s).	0.001 kg

Standards

EN 55015
 EN 60068-2-27 (shock – test case: 1,000 shocks in 6 directions with 30 g / 18 ms)
 EN 60068-2-64 (vibration – test case: acc. to table A.1 transport / category 2)
 EN 61000-3-2
 EN 61000-3-3
 EN 61347-1
 EN 61347-2-13
 EN 62384
 EN 61547
 EN 62386-102
 EN 62386-207
 According to EN 50172 for use in central battery systems
 According to EN 60598-2-22 suitable for emergency lighting installations

Overload protection

If the output voltage range is exceeded the LED Driver turns off the LED output. After restart of the LED Driver the output will be activated again. The restart can be done via mains reset.

Overtemperature protection

The LED Driver is protected against temporary thermal overheating. If the temperature limit is exceeded the output current of the LED is reduced. The temperature protection is activated approx. +5 °C above $t_{c\ max}$ (see page 3). On DC operation this function is deactivated to fulfill emergency requirements.

Short-circuit behaviour

In case of a short circuit at the LED output the LED output is switched off. After restart of the LED Driver the output will be activated again. The restart can be done via mains reset.

No-load operation

The LED Driver will not be damaged in the no-load operation. A voltage of 320 V DC is permanent at the output. In the first 5 seconds it can even be higher. If a LED load is connected the device has to be restarted before the output will be activated again.

Hot plug-in

Hot plug-in is not recommend after shutdown due to output voltage of > 0 V. If a LED load is connected the device has to be restarted before the output will be activated again. This can be done with mains reset.

Conditions of use and storage

Humidity: 5% up to max. 85%,
not condensed
(max. 56 days/year at 85%)

Storage temperature: -40 °C up to max. +80 °C

The devices have to be within the specified temperature range (t_a) before they can be operated.

Expected life-time

Type	Output current	t_a	40 °C	50 °C	55 °C	60 °C	65 °C	70 °C
LC 150W 350-900mA flexC IND sl ADV	350 – 900 mA	t_c	60 °C	70 °C	75 °C	80 °C	85 °C	90 °C
		Life-time	>200,000 h	200,000 h	140,000 h	100,000 h	70,000 h	50,000 h

The LED Driver is designed for a life-time stated above under reference conditions and with a failure probability of less than 10 %.

Maximum loading of automatic circuit breakers

Automatic circuit breaker type	C10	C13	C16	C20	B10	B13	B16	B20	Inrush current
Installation \varnothing	1.5 mm ²	1.5 mm ²	2.5 mm ²	2.5 mm ²	1.5 mm ²	1.5 mm ²	2.5 mm ²	2.5 mm ²	I_{max} time
LC 150W 350-900mA flexC IND sl ADV	8	12	14	20	4	6	7	10	60 A 200 μ s

Harmonic distortion in the mains supply (at 230 V / 50 Hz and full load) in %

	THD	3.	5.	7.	9.	11.
LC 150W 350-900mA flexC IND sl ADV	7	< 3,5	< 3,5	< 3,5	< 3	< 2

Light level in DC operation

The light level is always 15 % and cannot be adjusted.

Function: adjustable current (I-select)

„I-select resistor“

Adjustable range	350 – 900 mA
Step width	25 mA (see page 3)
Resistor value range	E96
Resistor value tolerance	± 1 %
Resistor power	≥ 0.1 W

If the resistor is connected with wires a max. wire length of 2 m may not be exceeded and possible interferences have to be avoided.

Resistors for the main output current values can be ordered from Tridonic (see accessories).

Electrical connections**IDC interface**

- solid wire with a cross section of 0.5 mm²

Horizontal interface

- solid wire with a cross section of 0.5–0.75 mm² with an insulation diameter up to 2.5 mm
- strip 8–9 mm of insulation from the cables to ensure perfect operation of the push terminals
- Loosen wire through simultaneously twisting and pulling

wire preparation:
0.5 – 0.75 mm²

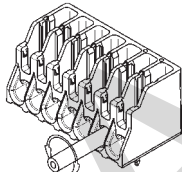
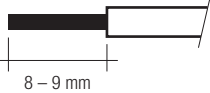

Loosen wire through
twisting and pulling

Wiring guidelines

- The cables should be run separately from the mains connections and mains cables to ensure good EMC conditions.
- The LED wiring should be kept as short as possible to ensure good EMC. The max. secondary cable length is 2 m (4 m circuit), this applies for LED output as well as for I-select.
- Secondary switching is not permitted.
- The LED Driver has no inverse-polarity protection on the secondary side. Wrong polarity can damage LED modules with no inverse-polarity protection.
- Wrong wiring of the LED Driver can lead to irreparable damage and no proper function is given anymore.
- With mains transients of 4 kV can voltage peaks up to 4 kV occur against PE at the output of the LED Driver. This has to be considered concerning the dielectric strength of the LED module (isolation against PE).

Earth connection

The earth connection is conducted as protection earth (PE). The LED Driver can be earthed via earth terminal or metal housing. If the LED Driver will be earthed, protection earth (PE) has to be used. There is no earth connection required for the functionality of the LED Driver.

Earth connection is recommended to improve following behaviour.

- Electromagnetic interferences (EMI)
- Transmission of mains transients to the LED output

In general it is recommended to earth the LED Driver if the LED module is mounted on earthed luminaire parts respectively heat sinks and thereby representing a high capacity against earth.

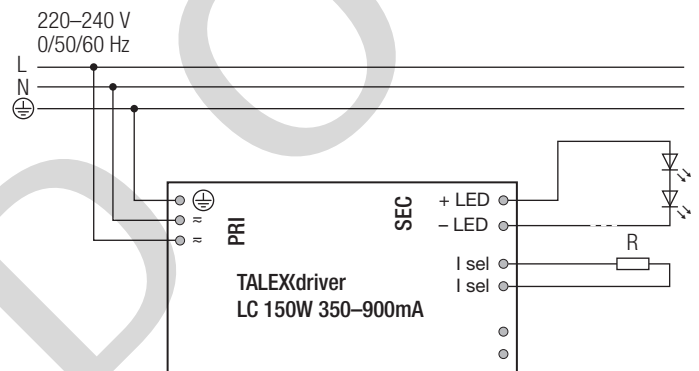
Circuit diagram**Isolation and electric strength testing of luminaires**

Electronic devices can be damaged by high voltage. This has to be considered during the routine testing of the luminaires in production.

According to IEC 60598-1 Annex Q (informative only!) or ENEC 303-Annex A, each luminaire should be submitted to an isolation test with 500 V_{DC} for 1 second. This test voltage should be connected between the interconnected phase and neutral terminals and the earth terminal. The isolation resistance must be at least 2 MΩ.

As an alternative, IEC 60598-1 Annex Q describes a test of the electrical strength with 1500 V_{AC} (or 1.414 x 1500 V_{DC}). To avoid damage to the electronic devices this test must not be conducted.

Additional information

Additional technical information at www.tridonic.com → Technical Data

Guarantee conditions at www.tridonic.com → Services

Life-time declarations are informative and represent no warranty claim. No warranty if device was opened.

Diagrams LC 150W 350-900mA flexC IND sl ADV

Efficiency vs load

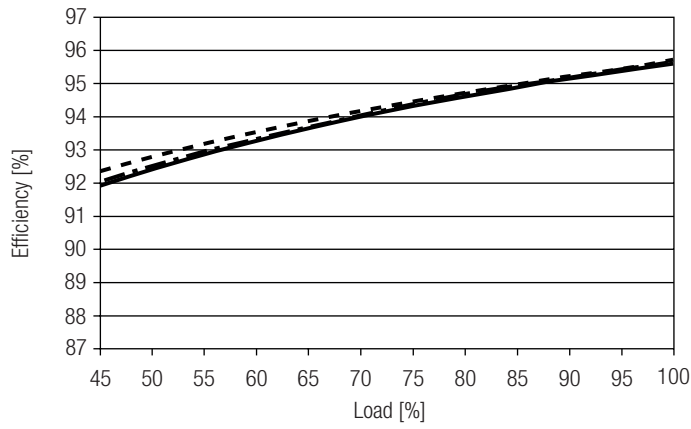

Power factor vs load

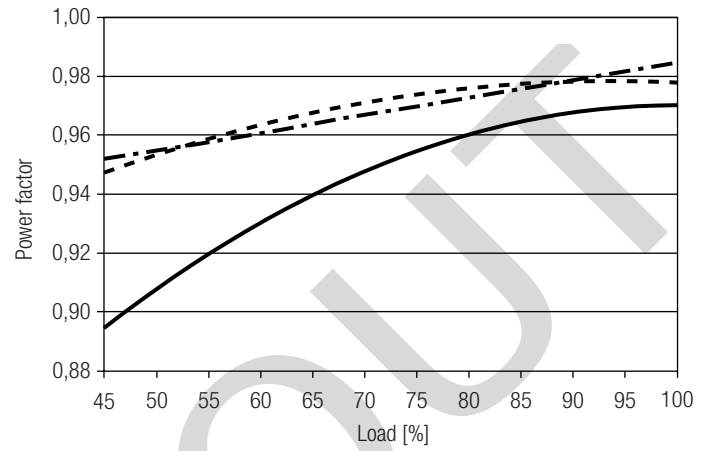

Input power vs load

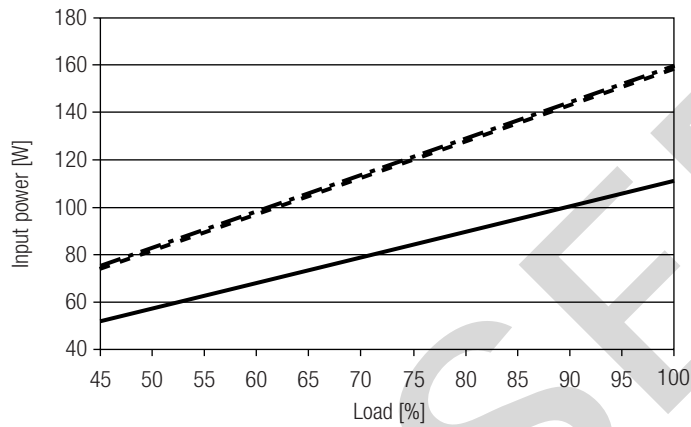

Input current vs load

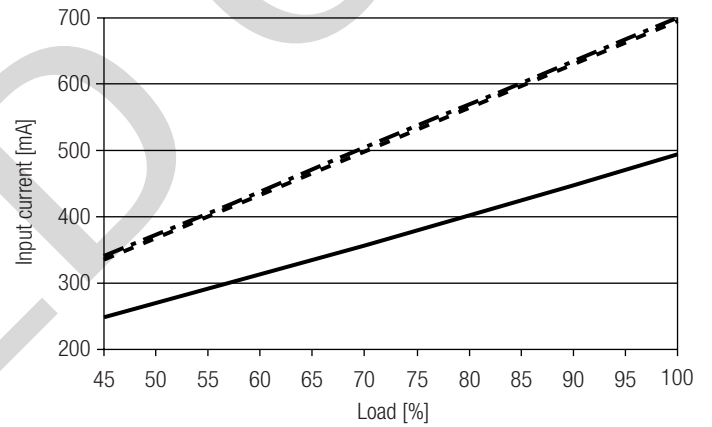

THD vs load

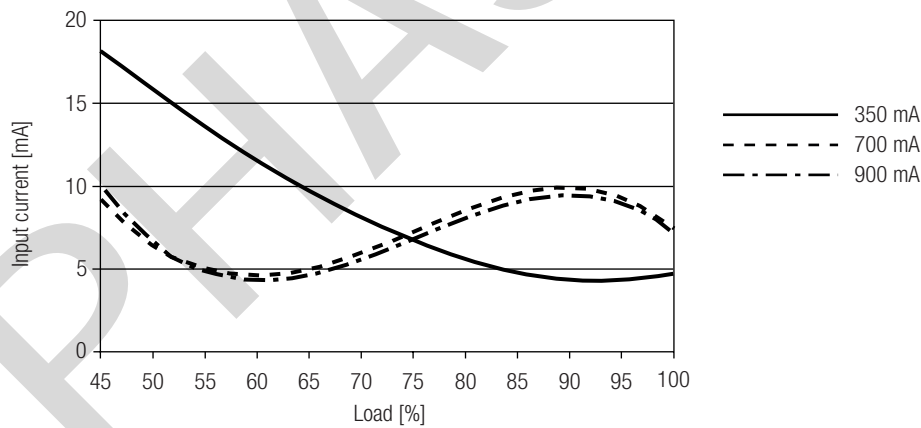

100 % load correspond to the max. output power (full load) according to the table on page 3.