



net4more driver 50W 100-400mA Ip unc

LED Driver for net4more systems

Product description

- Dimmable built-in constant current LED Driver for IP connected luminaires
- Adjustable output current between 100 and 400 mA via unc interface
- Max. output power 50 W
- Up to 90 % efficiency
- Dimming range 1 – 100 %
- Life-time up to 100,000 hours
- 5-year guarantee
- net4more articles are part of the net4more toolbox consisting of hardware and software and can be ordered with the system via your local sales team

Housing properties

- Low profile metal casing with white cover
- Type of protection IP20

Interfaces

- unc – RJ10 (4P4C)
- Terminal blocks: 0° push terminals

Functions

- Configuration and output current adjustment via unc interface
- Service monitor to log events
- Protective features (overtemperature, short-circuit, overload, no-load, input voltage range, reduced surge amplification)
- Suitable for emergency escape lighting systems acc. to EN 50172

Benefits

- Allows integration into IP connected lighting system
- Flexible configuration via unc interface
- Application-oriented operating window for maximum compatibility

Typical applications

- LED Driver for wired and wireless linear/area luminaires in office applications, in combination with dedicated net4more comMOD

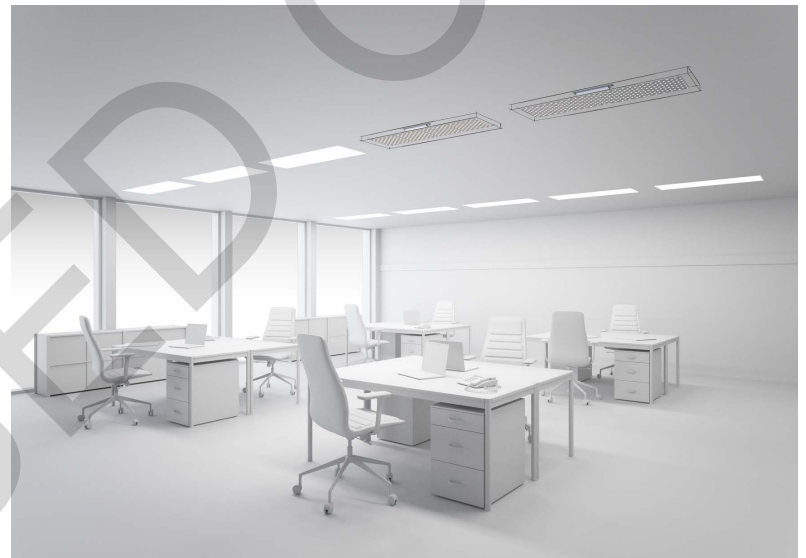

Standards, page 4

IP20

net4more driver 50W 100-400mA Ip unc

LED Driver for net4more systems

Technical data

Rated supply voltage	220 – 240 V
Input voltage, AC	198 – 264 V
Input voltage, DC	176 – 280 V
Mains frequency	0 / 50 / 60 Hz
Overvoltage protection	320 V AC, 48 h
Typ. current (at 230 V, 50 Hz, full load) ^① ^② ^③	90 – 244 mA
Typ. current (220 V, 0 Hz, full load, 15 % dimming level) ^② ^③	34 – 45 mA
Leakage current (at 230 V, 50 Hz, full load) ^② ^③	< 210 µA
Max. input power	55.1 W
Typ. efficiency (at 230 V / 50 Hz / full load) ^②	90 %
λ (at 230 V, 50 Hz, full load) ^②	0.98
Typ. input current in no-load operation	2.3 mA
Typ. input power in no-load operation	0.48 W
In-rush current (peak / duration)	29 A / 180 µs
THD (at 230 V, 50 Hz, full load) ^②	< 13.4 %
Time to light (at 230 V, 50 Hz, full load) ^②	< 1.15 s
Time to light (DC mode)	< 0.85 s
Switchover time (AC/DC)	< 0.36 s
Turn off time (at 230 V, 50 Hz, full load)	< 5 ms
Output current tolerance ^①	± 3 %
Max. output current peak (non-repetitive)	≤ output current + 15 %
Output LF current ripple (< 120 Hz)	± 5 %
Max. output voltage (no-load voltage)	250 V
Dimming range	1 – 100 %
Mains surge capability (between L – N)	1 kV
Mains surge capability (between L/N – PE)	2 kV
Surge voltage at output side (against PE)	< 500 V
Dimensions L x W x H	360 x 30 x 21 mm

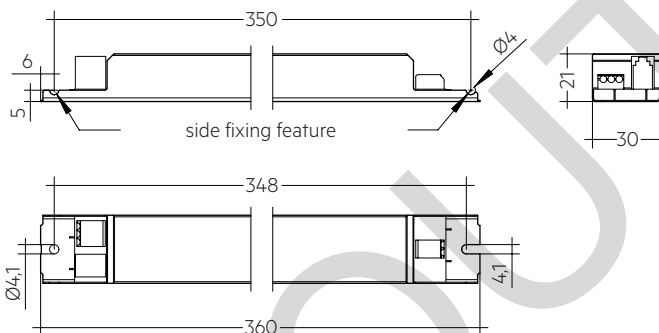

Ordering data

Type	Article number	Packaging carton	Packaging pallet	Weight per pc.
net4more driver 50W 100-400mA Ip unc	28001530	10 pc(s).	760 pc(s).	0.25 kg

Specific technical data

Type	Output current	Min. forward voltage	Max. forward voltage	Max. output power	Typ. power consumption (at 230 V, 50 Hz, full load) ^① ^②	Typ. current consumption (at 230 V, 50 Hz, full load) ^① ^②	Max. casing temperature tc	Ambient temperature ta max.
net4more driver 50W 100-400mA Ip unc	100 mA	50 V	140 V	14.0 W	18.4 W	90 mA	80 °C	-25 ... +60 °C
	125 mA	50 V	140 V	17.5 W	21.9 W	105 mA	80 °C	-25 ... +60 °C
	150 mA	50 V	140 V	21.0 W	25.4 W	119 mA	85 °C	-25 ... +60 °C
	175 mA	50 V	140 V	24.5 W	29.0 W	134 mA	85 °C	-25 ... +60 °C
	200 mA	50 V	140 V	28.0 W	32.6 W	148 mA	85 °C	-25 ... +60 °C
	225 mA	50 V	140 V	31.5 W	36.2 W	164 mA	85 °C	-25 ... +60 °C
	250 mA	50 V	140 V	35.0 W	39.9 W	179 mA	85 °C	-25 ... +60 °C
	275 mA	50 V	140 V	38.5 W	43.4 W	194 mA	85 °C	-25 ... +60 °C
	300 mA	50 V	140 V	42.0 W	47.1 W	210 mA	85 °C	-25 ... +60 °C
	325 mA	50 V	140 V	42.5 W	50.8 W	226 mA	85 °C	-25 ... +60 °C
	350 mA	50 V	140 V	49.0 W	54.4 W	241 mA	85 °C	-25 ... +60 °C
	375 mA	50 V	133 V	50.0 W	55.1 W	244 mA	85 °C	-25 ... +60 °C
	400 mA	50 V	125 V	50.0 W	54.9 W	244 mA	85 °C	-25 ... +60 °C

^① Valid at 100 % dimming level.

^② Depending on the selected output current.

^③ Measurement values without devices at unc bus.

1. Standards

EN 55015
EN 61000-3-2
EN 61000-3-3
EN 61347-1
EN 61347-2-13
EN 62384
EN 61547

According to EN 50172 for use in central battery systems

According to EN 60598-2-22 suitable for emergency lighting installations

2. Thermal details and life-time

2.1 Expected life-time

Expected life-time

Type	Output current	ta	40 °C	50 °C	55 °C	60 °C
100 mA	tc		60 °C	70 °C	75 °C	80 °C
	Life-time		> 100,000 h	> 100,000 h	95,000 h	65,000 h
> 100 – 200 mA	tc		65 °C	75 °C	80 °C	85 °C
	Life-time		> 100,000 h	> 100,000 h	85,000 h	60,000 h
net4more driver 50W 100-400mA Ip un:c	tc		65 °C	75 °C	80 °C	85 °C
	Life-time		> 100,000 h	> 100,000 h	75,000 h	60,000 h
> 200 – 300 mA	tc		65 °C	75 °C	80 °C	85 °C
	Life-time		> 100,000 h	> 100,000 h	75,000 h	60,000 h
> 300 – 400 mA	tc		65 °C	75 °C	80 °C	85 °C
	Life-time		> 100,000 h	> 100,000 h	75,000 h	55,000 h

The LED Driver is designed for a life-time stated above under reference conditions and with a failure probability of less than 10 %.

The relation of tc to ta temperature depends also on the luminaire design.

If the measured tc temperature is approx. 5 K below tc max., ta temperature should be checked and eventually critical components (e.g. ELCAP) measured. Detailed information on request.

3. Installation / wiring

3.1 Circuit diagram

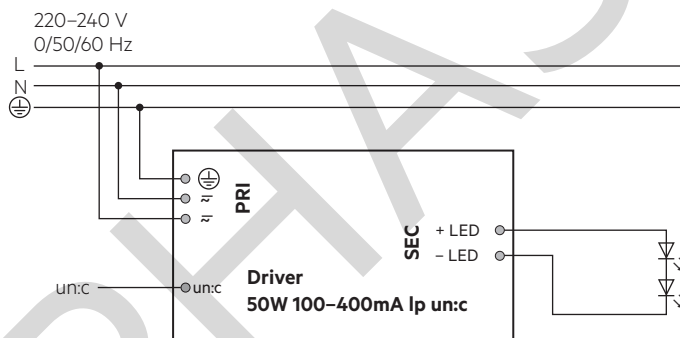

3.2 Wiring type and cross section

Solid wire with a cross section of 0.5 – 1.5 mm². Strip 8 – 9 mm of insulation from the cables to ensure perfect operation of terminals.

LED module/LED Driver/supply

wire preparation:
0.5 – 1.5 mm²

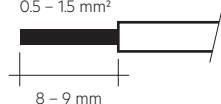

3.3 Loose wiring

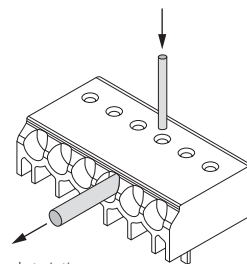

Loosen wire through twisting and pulling or using a Ø 1 mm release tool

3.4 un:c interface / RJ10

The connection between communication module and LED Driver must be done via a straight through un:c interface cable.

un:c (RJ10)	
pin 1	STR
pin 2	5V
pin 3	GND
pin 4	SCL

3.5 Wiring guidelines

- The cables should be run separately from the mains connections and mains cables to ensure good EMC conditions.
- The LED wiring should be kept as short as possible to ensure good EMC. The max. secondary cable length is 2 m (4 m circuit), this applies for LED output.
- Secondary switching is not permitted.
- The LED Driver has no inverse-polarity protection on the secondary side. Wrong polarity can damage LED modules with no inverse-polarity protection.
- Wrong wiring of the LED Driver can lead to malfunction or irreparable damage.

3.6 Hot plug-in

Hot plug-in is not supported due to residual output voltage of > 0 V. If a LED load is connected the device has to be restarted before the output will be activated again. This can be done via mains reset or via interface (un:c).

3.7 Earth connection

The earth connection is conducted as protection earth (PE). The LED Driver can be earthed via earth terminal or metal housing. If the LED Driver will be earthed, protection earth (PE) has to be used. There is no earth connection required for the functionality of the LED Driver. Earth connection is recommended to improve following behaviour.

- Electromagnetic interferences (EMI)
- LED glowing at stand-by
- Transmission of mains transients to the LED output

In general it is recommended to earth the LED Driver if the LED module is mounted on earthed luminaire parts respectively heat sinks and thereby representing a high capacity against earth.

4. Electrical values

4.1 Operating window

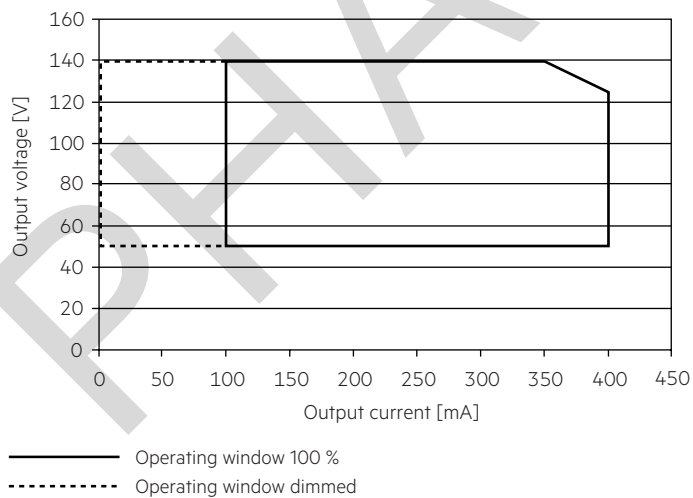

If you run the device outside specification a limitation may be active. This is a technical aspect from the amplitude modulation dimming.

4.2 Efficiency vs load

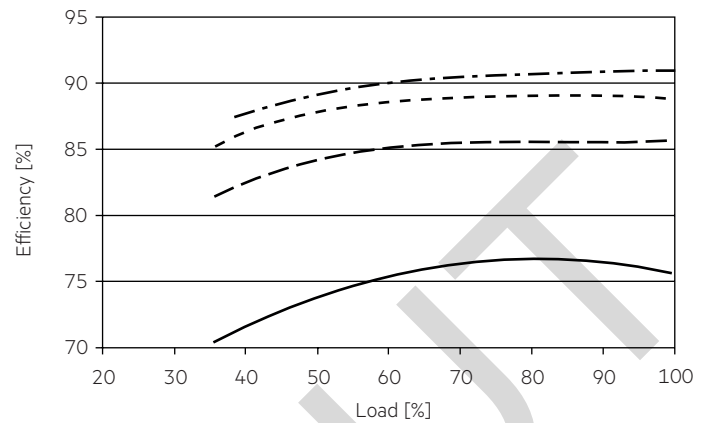

4.3 Power factor vs load

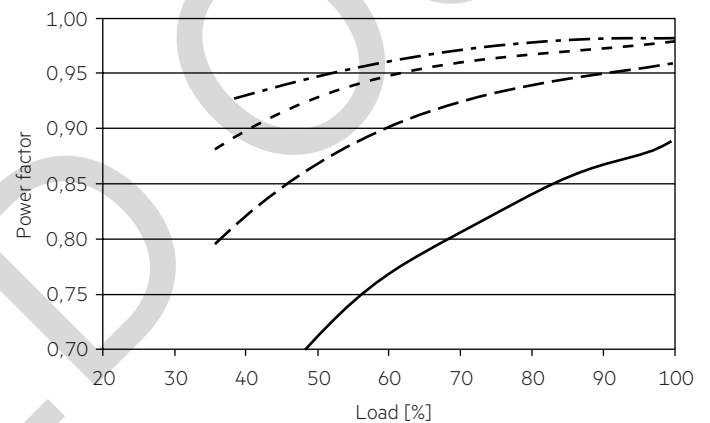

4.4 THD vs load

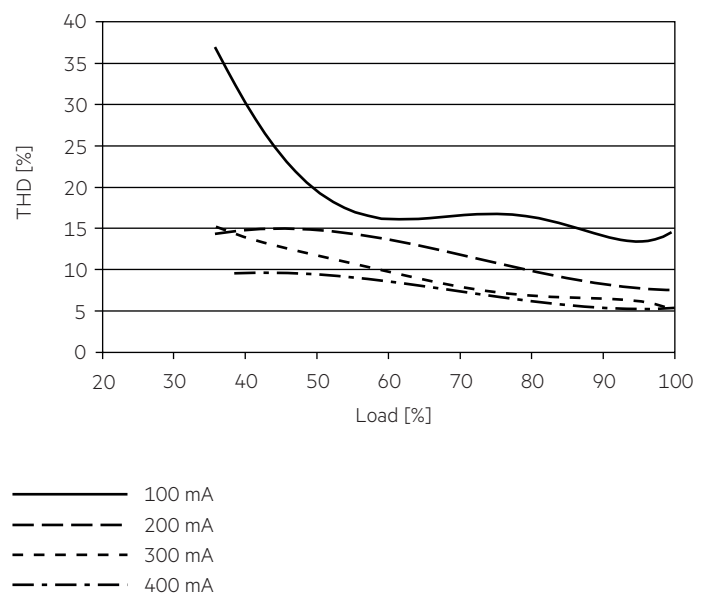

100 % load corresponds to the max. output power (full load) according to the table on page 2.

4.5 Maximum loading of automatic circuit breakers

Automatic circuit breaker type	C10	C13	C16	C20	B10	B13	B16	B20	Inrush current	
Installation Ø	1.5 mm ²	1.5 mm ²	2.5 mm ²	2.5 mm ²	1.5 mm ²	1.5 mm ²	2.5 mm ²	2.5 mm ²	I_{max}	time
net4more driver 50W 100-400mA Ip unc	22	28	37	45	13	17	22	27	29 A	180 µs

Calculation uses typical values from ABB series S200 as a reference.
Actual values may differ due to used circuit breaker types and installation environment.

4.6 Harmonic distortion in the mains supply (at 230 V / 50 Hz and full load) in %

	THD	3.	5.	7.	9.	11.
net4more driver 50W 100-400mA Ip unc	< 9	< 9	< 3	< 3	< 2	< 1

4.7 Dimming

Dimming range 1% to 100 %

Digital control via unc interface.

4.8 Dimming characteristics

Digital dimming value

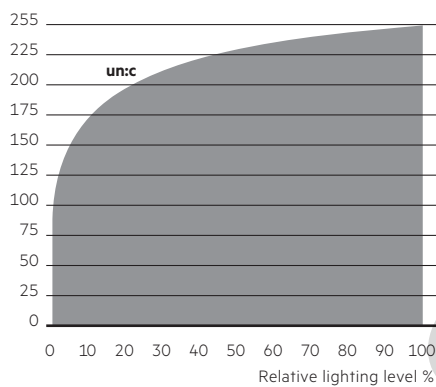

Dimming characteristics as seen by the human eye and is based on the DSI curve.

5. Interfaces / communication

5.1 unc interface

Parameter	Value
Output voltage	5 V
Min. output voltage	4,2 V
Max. output voltage	5,5 V
Max. output current	400 mA
Max. cable length ^①	15 m
Bus frequency	100 / 400 kHz
Devices per bus	10

① The max. cable length corresponds to the sum of all lines in unc interface.

Details see net4more Design-In Guide.

6. Functions

6.1 Adjustable current

The output current of the LED Driver can be adjusted in a certain range. The adjustment can be made by software via un:c interface.

6.2 Short-circuit behaviour

In case of a short-circuit at the LED output the LED output is switched off. After restart of the LED Driver the output will be activated again. The restart can either be done via mains reset or via un:c.

6.3 No-load operation

The LED Driver will not be damaged in no-load operation. The output will be deactivated and is therefore free of voltage. If a LED load is connected the device has to be restarted before the output will be activated again.

6.4 Overload protection

If the output voltage range is exceeded the LED Driver turns off the LED output. After restart of the LED Driver the output will be activated again. The restart can either be done via mains reset and un:c.

6.5 Overtemperature protection

The LED Driver is protected against temporary thermal overheating. If the temperature limit is exceeded the output current of the LED module(s) is reduced. The temperature protection is activated approx. +5 °C above $t_{c \max}$ (see page 2). On DC operation this function is deactivated to fulfill emergency requirements.

6.6 Power-up fading

The power-up function offers the opportunity to modify the on-behavior. The time for fading on can be adjusted in a range of 0.2 to 16 seconds. According to this value, the device dims either from 0 % up to the power-on level. By factory default no fading time is set (= 0 seconds).

6.7 Light level in DC operation

Programmable from 1 – 100 % (EOF_i = 0.13)
Programming by un:c interface.
Default value is 15 %
In DC operation dimming mode can be activated.

7. Miscellaneous

7.1 Isolation and electric strength testing of luminaires

Electronic devices can be damaged by high voltage. This has to be considered during the routine testing of the luminaires in production.

According to IEC 60598-1 Annex Q (informative only!) or ENEC 303-Annex A, each luminaire should be submitted to an isolation test with 500 V_{DC} for 1 second. This test voltage should be connected between the interconnected phase and neutral terminals and the earth terminal. The isolation resistance must be at least 2 MΩ.

As an alternative, IEC 60598-1 Annex Q describes a test of the electrical strength with 1500 V_{AC} (or 1.414 x 1500 V_{DC}). To avoid damage to the electronic devices this test must not be conducted.

7.2 Conditions of use and storage

Humidity: 5 % up to max. 85 %,
not condensed
(max. 56 days/year at 85 %)

Storage temperature: -40 °C up to max. +80 °C

The devices have to be acclimatised to the specified temperature range (ta) before they can be operated.

7.3 Additional information

Additional technical information at
www.tridonic.com → Technical Data

Guarantee conditions at
www.tridonic.com → Services

Details see Design-In Guide.

Life-time declarations are informative and represent no warranty claim.
No warranty if device was opened.